

The OVH ARC Newsletter
OLE VIRGINIA HAMS™ AMATEUR RADIO CLUB, INC.
Post Office Box 1255, Manassas, Va. 20108
OVH FM Repeaters - 146.970- & 224.660- & 442.200+ & 443.500+
OVH D-STAR Repeaters - W4OVH - 146.865- & 442.5125+ (temporarily - limited functionality)
Web Site at <http://w4ovh.net>

OLE VIRGINIA TIMES

December 2020

Next Meeting: January 19, 2021 - likely online, see below

PRESIDENT'S LETTER:

Greetings everyone,

With Thanksgiving behind us and the cold weather here, it means we're rounding the corner on another year. Pretty soon we'll be saying goodbye to 2020 and hoping for a good 2021. If recent conditions on the HF bands are any indication, we may be in for a good year; not that I've been able to do any operating.

I hope everyone had a good Thanksgiving and those who attended the Year End - Holiday Party had a good time. I have to apologize for my absence; just a few days before Thanksgiving the mild nagging pain in my back from my previous back injury turned in to a full-blown problem. The last few weeks have been pretty rough, but I got through it once and I'll get through it again. I would like to congratulate John / KG4NXT for receiving Life Time Achievement award and Jeff / WB6UIE for receiving an Appreciation award for all of his diligent work as Vice President. Also a Thank You to everyone to donated gifts to Toys 4 Tots during this difficult year, and to Theresa / KG4TVM for organizing everything. Some pictures and an article are available on the OVH web site and later in this Newsletter.

I'm also saddened to report that Steve Meade / KB4OF has become a SK (Silent Key). Steve was a very active member of the club for many years, and will be remembered by all who knew him. Most recently, he was an active participant as a VE examiner at the OVH's VE session in June. My condolences to his family. Thanks to the work of Theresa / KG4TVM, OVH has made a donation in Steve's memory to Vietnam Veterans of America.

We will not be having an OVH online monthly meeting this Tuesday -



Cont'd on Page 3

Ole Virginia Hams Amateur Radio Club, Inc.

Post Office Box 1255
Manassas, Virginia 20108

OFFICERS

President:	Jay Moore	NQ4T	571-316-4738
Vice Pres:	Jeff Fuller	WB6UIE	791-5916
Secretary:	John Heartney	KG4NXT	257-3566
Treasurer:	Don Meyerhoff	WA2SWX	597-3211

DIRECTORS

Don (Butch) Blasdell	W4HJL	369-2877
Arthur Whittum	W1CRO	791-4330
Charlie Dale	WA4YGI	361-3091
Bob Zaepfel	K4HJF	282-2451

WEEKLY FM REPEATER NET COORDINATOR

Thurs - 8:00 PM Local Time	JOHN / KG4NXT	257-3566
----------------------------	------------------	----------

HAMFEST 2020 - Chairman

Don	WA2SWX	597-3211
-----	--------	----------

FIELD DAY 2020

Byron	AK4XR	222-2095
-------	-------	----------

CLUB ROSTER / DATABASE

Arthur	W1CRO	791-4330
--------	-------	----------

EDUCATION

Mark	WA4KFZ	818-8033
------	--------	----------

CLUB EMERGENCY COORDINATOR

Open

ARES - EMERGENCY COORDINATOR

David Lane	KG4GIY	703-628-3868
	email: KG4GIY@ARRL.NET	

Prince William County ARES website <http://pwcares.org>

FINANCE

Arthur	W1CRO	791-4330
Mark	WA4KFZ	818-8033
Don	WA2SWX	597-3211

GENERATORS

Steve	N4OGR	361-0008
Al	KB4BHB	368-4794

HISTORIAN

Theresa	KG4TVM	257-3566
---------	--------	----------

WEB COMMITTEE — W4OVH.NET

Kevin	KX4KU	540-445-5183
Andy	KJ4MTP	786-4651
John	KG4NXT	257-3566
Ken	KN4DD	622-2638

EMAIL REFLECTOR — w4ovh@googlegroups.com

David Lane	KG4GIY	628-3868
------------	--------	----------

JOTA - 2020

John	KG4NXT	257-3566
------	--------	----------

LEGAL

Bob	K4HJF	282-2451
-----	-------	----------

MEMBERSHIP CHAIRMAN

Luther	WA3FMO	361-4885
--------	--------	----------

NEWSLETTER

Paul	W4ZB	754-0910
------	------	----------

NEWSLINE FOR THE WEEKLY NET

John.	KG4NXT	257-3566
-------	--------	----------

PROGRAMS

Jeff	WB6UIE	791-5916
------	--------	----------

QUARTERMASTER

Steve	N4OGR	361-0008
-------	-------	----------

REPEATER CONTROLLERS

John	KG4NXT	257-3566
Ken	KE2N	753-8587
George	K4GVT	791-5956
Arthur	W1CRO	791-4330
Butch	W4HJL	369-2877
Steve	N4OGR	361-0008
David	KG4GIY	361-3042
Cat	KM4PBD	571-213-2179

W4OVH — TRUSTEE

Wayne	N7QLK	571-237-0520
-------	-------	--------------

W4PVA — TRUSTEE

Arthur	W1CRO	791-4330
--------	-------	----------

SCHOLARSHIP

Sandy Knight	KM4JUS	901-4664
--------------	--------	----------

SUNSHINE

Theresa	KG4TVM	257-3566
---------	--------	----------

TECHNICAL COMMITTEE

Ken	KE2N	753-8587
Andy	KJ4MTP	786-4651
George	K4GVT	791-5956
Arthur	W1CRO	791-4330
Butch	W4HJL	369-2877
Bob	K4HJF	335-1939
David	KG4GIY	628-3868

TWITTER & FACEBOOK ACCOUNT MODERATOR

Jeff	KM4FTK	830-4155
------	--------	----------

All telephone numbers listed above are for Area Code 703 unless otherwise noted. This is the official monthly publication of the Ole Virginia Hams Amateur Radio Club, Inc., a §501(c)(3) organization, dedicated to the promotion and enhancement of Amateur Radio. Copyright © 2020 by the Ole Virginia Hams which holds its regular monthly meeting is at 7:30 p.m. every third Tuesday at the Buckhall Volunteer Fire Department Station, 7190 Yates Ford Road, Manassas, Virginia. Members, prospective members and other interested persons are invited to attend without obligation. Local information can also be obtained through the OVH's FM repeaters on 146.970-, 224.660-, 442.200+ and 443.500+ MHz. Up to date information about OVH activities and its meetings is also available during the OVH's nets on its FM Repeater each Thursday night at 8:00 p.m. or through the OVH's web site at <http://w4ovh.net>. Articles in this newsletter may be reprinted if credit is given to the OVH ARC and other source(s) noted. Proposed materials for publication, classified ads, notes about specific errors, complaints or the like are solicited. Forward such items to the Newsletter Editor: PAUL@W4ZB.COM. Approx. Circ.: 170. Last Rev: 20200310

December 15th as it is traditionally replaced by a brief meeting during the Holiday Party. There was a brief meeting during the Holiday Party on December 6th, and all pending applicants for club membership who had been read in at the November meeting were voted in. Welcome to the OVH!

We will next be meeting again on January 19, 2021, most likely still online - details for it will be posted in January. Until then, make sure to drop by our Thursday night net.

I would like to thank Mark / WA4KFZ for his wonderful presentation on his fox hunt antenna attenuator project at last month's meeting. Hopefully when the weather warms up we'll be able to get out there and see how it works.

Of course, with the end of the year approaching, it is that time again, renewal dues for 2021 are coming up. You can renew online via a PayPal link on the OVH Web site's member page; or print and fill out the form this Newsletter and mail that in with a check.

Hope everyone has a safe and Happy Holidays and New Years. See you next year for, hopefully, a more active 2021.

73 Jay NQ4T

Sunshine Corner

Happy birthday in December to the following club members: David / KK4ZUU, Bill / N4SV, Tony / KM4KLB, David / KJ4EPF, Ed / KK4PHP, Dianne / KI4FVV, Charles / WA1FFX and Jay / N4QT. Hoping you all are able to enjoy your special day during this Holiday season!

The OVH Year End Holiday Party took place on Sunday, December 6th, at the Yorkshire Restaurant from 6:00 pm to 8:00 pm. Due to COVID, there was a considerably smaller turnout than usual, but still quite a few OVH members and family were there and all had a good time, the first formal OVH club get together in quite a while. See article and pictures later in this Newsletter.

Best wishes to our club members that have been dealing with health issues, hope you all are up and running at full speed soon. I'm sad to report that Steve Meade / KB4OF passed away. Steve was a very active member of the club for many years, and will be remembered by all who knew him. Most recently, he participated as a VE examiner at the OVH's VE session in June. The OVH has made a donation in Steve's memory to Vietnam Veterans of America.

Manassas Hamfest 2021 planning meetings have already started and we are planning to put it on if at all possible in view of the COVID situation. Contact Don / WA2SWX and let him know how you can participate to make this a successful event.

Please mark your calendar for Winter Field Day in early 2021, on January 30th and 31st. Contact Don / WA2SWX, John / KG4NXT or Theresa / KG4TVM for more information on this event. More to be provided as the event gets closer.

Remember to check in at 8 PM on the OVH's Thursday night VHF/UHF repeater net - details are on the OVH's web site: W4OVH.NET. Continue to send news or other items to me, email at kg4tvm@hotmail.com or telephone: 703-257-3566. !

Merry Christmas and Happy Holidays and New Year to everyone!

73 Theresa KG4TVM



Minutes of the Ole Virginia Hams Amateur Radio Club Meeting held on November 17, 2020 Online:

The OVH regular meeting for November 2020 was held over the Internet using the Jitsi platform hosted by Jay / NQ4T at <https://ovh.nq4t.com/meeting> The meeting began at 7:30 PM on November 17th and the Jitsi attendee counter counted a peak number of 24 attendees. Because the meeting was being held virtually, OVH President Jay / NQ4T dispensed with the pledge and individual attendees saying their call signs.

OVH President Jay / NQ4T ran the meeting.

Mark / WA4KFZ provided a very professional online presentation about a variable attenuator device that he designed and built for Fox Hunts. It has a low battery drain and is wearable on a belt. Mark shows slides explaining the theory of operation and these slides will be put on the club reflector. Mark intends to write this project up and submit it to the ARRL magazine QEX.

The minutes of the October meeting were approved.

Treasurer's report - no report.

Luther / WA3FMO gave the membership report. There were four new members voted in: David Greenhill / KO4HIR; David Curley / No callsign yet; Matthew Burdick / No callsign yet; and Tyssen Becker / W8ZM. Luther also had 2 new read-ins: Paul Potter / KO4GZR and Kyle Ahmadi / No callsign yet.

Greg / KM4CCG gave the ARES report. The Marine Marathon training was cancelled.

Ken / KE2N give the repeater report. He updated everyone on the lightning strike damage at NOVEC. The 220 Mhz repeater is back from Bridgecom with the aux card replaced. Ken is bench testing it before he puts it back in service. When he puts it back in service, he will also add a USB isolator, several Ethernet isolators and a heavy duty surge protector. Ken will also install a proper bonding cable on and between the various items of equipment to equalize their ground potentials. Ken also mentioned that the D-Star has a new power supply and that solved its problem but that the DStar is not yet back online.

Mark WA4KFZ gave the training report. He has no classes scheduled but is willing to do mentoring. Mark also mention a bizarre email he got, which did not come through the OVH web site.

Hamfest report. No report, but the Hamfest Committee is believed to be in somewhat of a holding pattern, depending on what happens with the COVID situation, but the plans are to go forward and hold the Manassas Hamfest in June if at all possible. .

Kevin / KX4KU gave the web committee report. John KG4NXT and Ken KN4DD are writing web articles. After discussion, the license class breakdown on the initial page of the web site will be removed because it is not automated..

Theresa / KG4TVM gave the Sunshine report. Steve Meade / KB4OF has become a silent key. The OVH holiday party is scheduled for December 6th. Invitations have been sent. She contacted the Marines who report there is a great shortage of Toys For Tots this year. Please bring new unwrapped toys to the party. Please also bring a covered dish. In addition, we will be having a Winter Field Day operation at the Shenandoah River State Park on January 30-31, 2021 and all are welcome to visit and operate.

No new business; and the meeting was adjourned.

Minutes of the Ole Virginia Hams Amateur Radio Club Meeting held on December 6, 2020 During the Holiday Party:

An abbreviated meeting was held at the Yorkshire Restaurant during and as part of the annual OVH Year End Holiday Party.

Theresa / KG4TVM ran the meeting. Theresa announced three Club awards for 2020. There was an Appreciation award for Jeff / WB6UIE who has been doing an outstanding job as OVH Vice President, an Appreciation award for Jay / NQ4T who has been doing a superb job as OVH President since February 2020 in these difficult COVID times, and a Life Time Achievement award for his many ham radio activities and achievement to John / KG4NXT.

It was moved and seconded that two new applicants for OVH membership who had been read in during the November 2020 online meeting be voted in: Paul Potter / KO4GZR and Kyle Ahmadi / No Callsign yet. The motion passed.

The meeting was adjourned.

Reminders about some upcoming events / calendar dates:

HAMFEST TYPE EVENTS:

The COVID pandemic, unfortunately, has killed off almost all live hamfests for the time being. Nothing is scheduled nearby. The Frostfest Hamfest at Richmond, Virginia which would normally occur in the beginning of February has already been cancelled for 2021, but it also has already been scheduled for 2022 - for February 6, 2022.

The OVH is still planning to put on the Manassas Hamfest as a "live" event in June. Date and more details to be announced.

HAM RADIO OPERATING / CONTEST EVENTS:

Hams active on the HF bands report that DX conditions are improving noticeably.

The ARRL has a Contest web page at its web site, but a much more comprehensive, up-to-date, and long range planning contesting calendar with links to the rules for the various events is maintained at <http://www.hornucopia.com/contestcal> by WA7BNM. If you get the radio contesting bug or just want to find out what and how much is going on, that is a good place to look!

PUBLIC SERVICE / ARES EVENTS

The Manassas Christmas Parade for 2020 (its 75th time) was cancelled, but plans are that it will take place again in December 2021.

Check the online Calendar on the OVH web site, W4OVH.NET for information about upcoming events.

Check the online Calendar by David / KG4GIY at <http://pwcares.org> for the latest PWC ARES updates. David maintains a comprehensive calendar for upcoming events at that web site. Complete direct contact information for David appears on page 2 of this Newsletter.

OVH Year End Holiday Party - December 6, 2020

The OVH held its annual OVH Year End Holiday Party at Yorkshire Restaurant on December 6, 2020. Due to COVID, attendance was down but still a good number of members attended with family members and everyone had a good time.

Because of the virus, everyone wore masks when not eating. In addition, the restaurant had blocked off every other table to help with social distancing. We had the usual ham, turkey and venison chili for the main dishes. This year the venison was provided by Gil / KM4OZH who had shot a 10 point buck. There were a number of side dishes and desserts brought by OVH members.

As usual, we also collected Toys for Tots. Several members that could not attend, nevertheless, donated toys, including Gene / N4HFN; Wayne / N4HCR; Sandy / KM4OZH; Ray / KM4EKR and Al / KB4BHB. We had two Marines from the Toys for Tots program come to the event for dinner and collect the Toys for Tots.

There was a brief monthly business meeting. Theresa presented Appreciation awards for Jeff / WB6UIE and Jay / NQ4T who have been outstanding jobs as key OVH club officers, and a Life Time Ham Radio Achievement award to John / KG4NXT. There was a motion to vote in the member applicants read in during the November 2020 online OVH meeting and that motion passed. The meeting was adjourned.

A few pictures from the OVH Year End Holiday Party follow:



Some Drone Aerial Camera Images of the W4OVH Repeater Antenna Installations on the Mount Pone Water Tank - [thanks to George / K4GVT!]

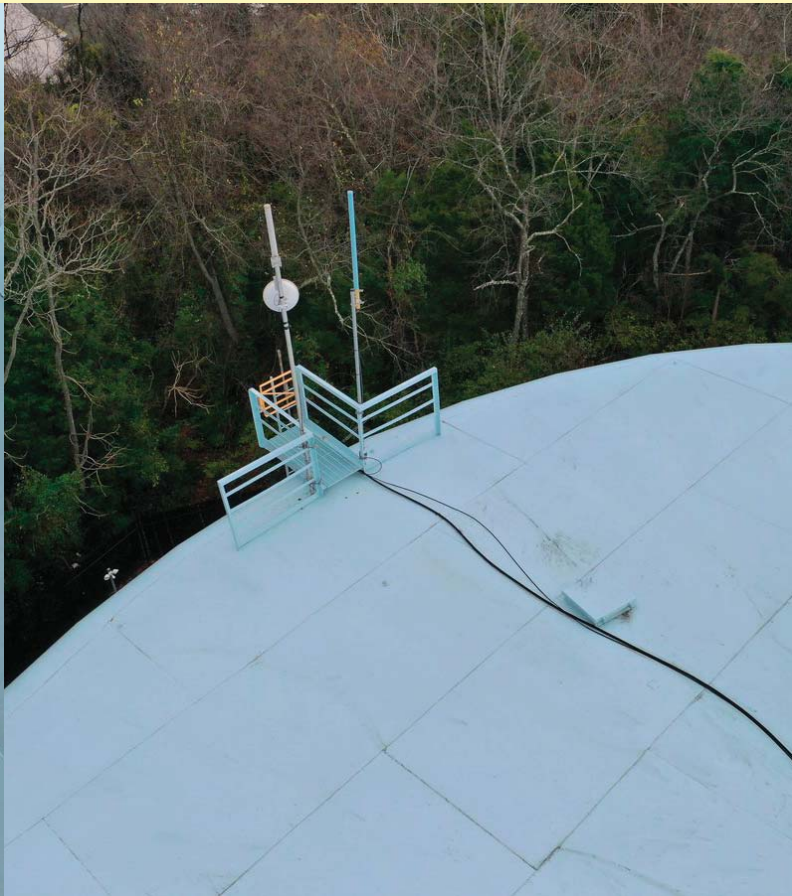

Foxhunt Attenuator

by Mark / WA4KFZ

Attenuator Methods

Switched Pi Network Method



Frequency Offset Method

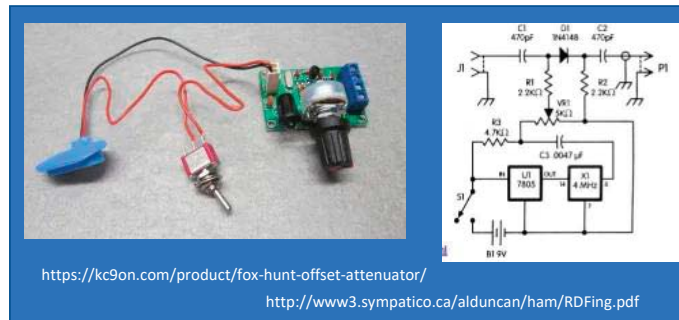

3rd Harmonic Method



- Bulky
- No rapid control
- \$110

- High starting insertion loss
- Intermodulation susceptibility
- \$15

- Best for close-in use only

Attenuator Block Diagram

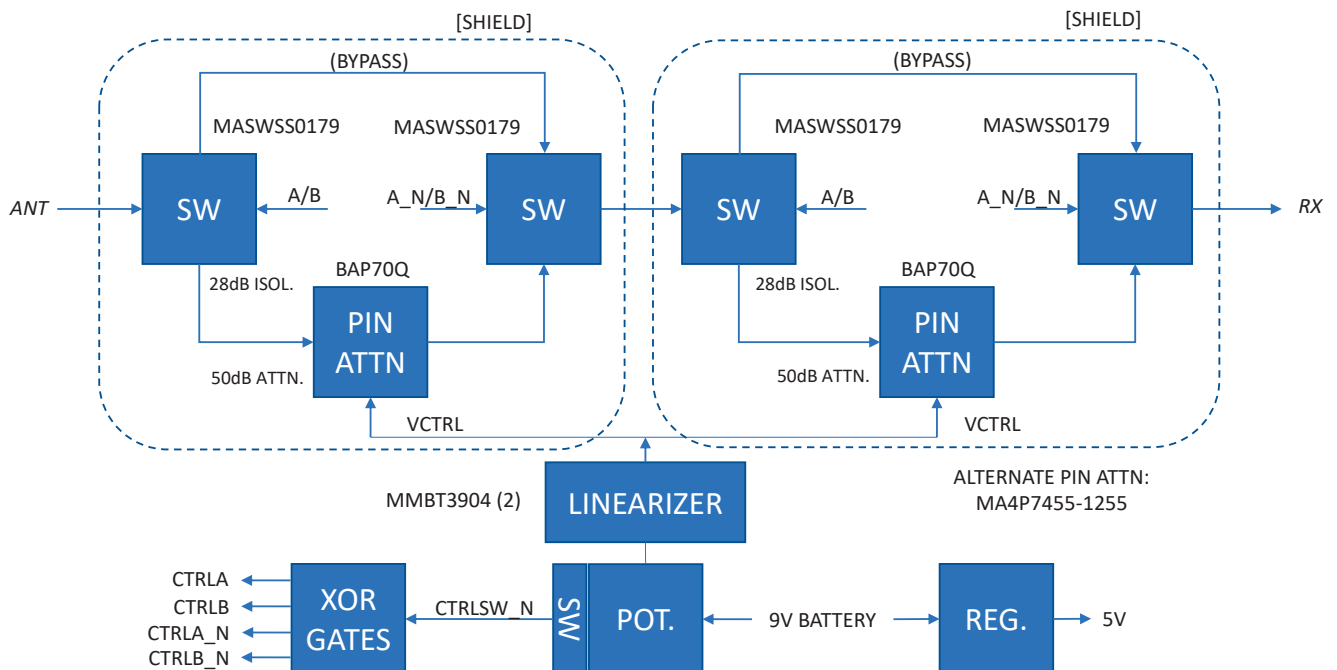

Cont'd on page 9

Top View (covers removed) As Built Circuit Board Photos

Bottom View

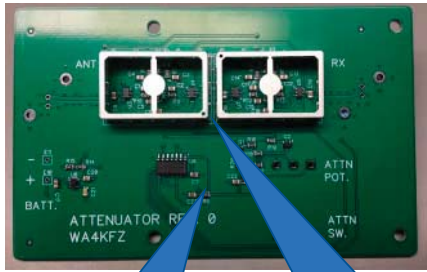

- Voltage Regulator
- Switch Logic
- Linearizer

- Bypass Switches
- PIN Attenuators

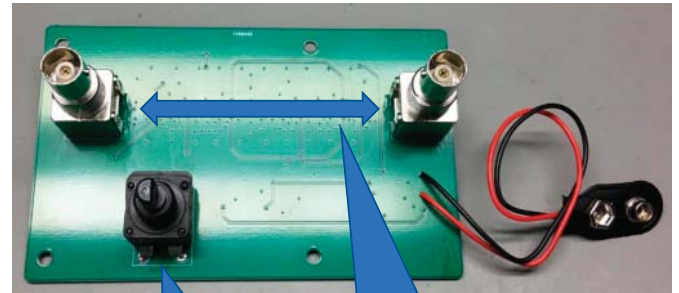

Potentiometer with Switch

Antenna & Radio Connectors (interchangeable)

Measurements - RF

Mode	VHF	UHF
Bypass	1.8dB	1.8dB
Full Atten.	80dB	78dB
Min. Atten.	13.5dB	13.6dB

- Usable from 50MHz – 2000MHz
- Input P1dB > +10dBm
- No damage at 0.5W input
 - *Use PTT lockout to prevent damage*

VHF

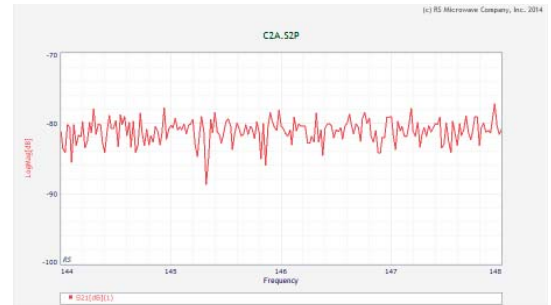

UHF

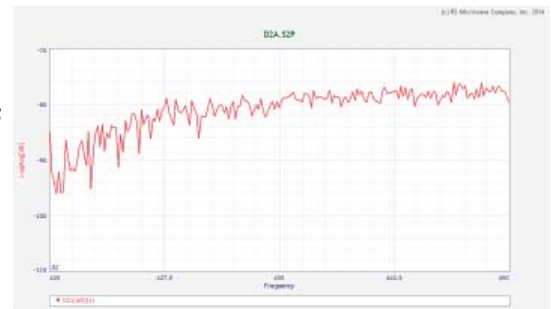

Measurements - DC

Mode	Current (mA) @ 9VDC
Bypass	0.5507
Full Atten.	1.0517
Min. Atten.	4.929

- Current consumption is lowest in bypass mode
- Current consumption increases as attenuation decreases
- 9V battery capacity 500mAh typ.

Battery is removed when unit is not in use



REMINDER



Yes, it is that time of year again!!!! Below is the 2021 Renewal Application.

Please fill out the form below (for database), attach your check and mail to the address below or drop off at a meeting. Be sure to update all information, including your e-mail address, telephone number(s) and nine digit ZIP

MEMBERSHIP RENEWAL APPLICATION "OLE VIRGINIA HAMS AMATEUR RADIO CLUB" for 2021

NAME: _____
ADDRESS: _____

CALL SIGN: _____
Home Tel: _____
Cell Tel: _____
Work Tel: _____
EMAIL: _____
BIRTHDAY: _____

ARE YOU PRESENTLY AN ARRL MEMBER? (YES/NO)

ARE YOU A VOLUNTEER EXAMINER: (YES/NO)

MAY YOUR TELEPHONE NOS. BE LISTED IN THE "Members Only" OVH ROSTER? (YES/NO)

WHAT IS YOUR PRESENT LICENSE CLASS? _____

Dues are now **\$20.00** per year and payable on January 1, 2021. Dues for each additional family member living at the same mailing address are \$10.00. Dues for a full time student at the college undergraduate or lower level [list school attended and grade or level: _____] are \$10.00.

NAME AND CALL OF FAMILY MEMBERS:

Name: _____
Name: _____

AMOUNT ENCLOSING: _____

Call: _____
Call: _____

Return to: **Treasurer, OVH**
P.O. Box 1255
Manassas, VA 20108-1255